

Surface Mount Transient Voltage Suppressors

Uni-directional

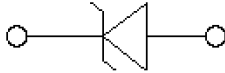

Bi-directional

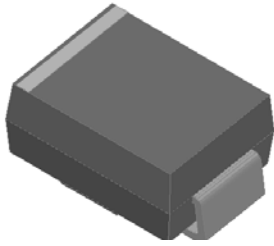
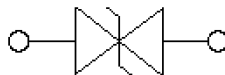
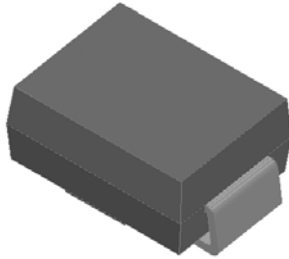

Features

- For surface mounted applications
- Low-profile package
- Ideal for automated placement
- Available in Unidirectional and Bidirectional
- 1000W peak pulse power capability with a 10/1000 μ s waveform
- Low incremental surge resistance, excellent clamping capability
- Very fast response time
- Meets MSL level 1, per J-STD-020C, LF maximum peak of 260 °C
- ESD protection of data lines in accordance with IEC 61000-4-2, 30kV(Air), 30kV (Contact)
- Part no. with suffix "Q" means AEC-Q101 qualified

Typical Applications

For use in sensitive electronics protection against voltage transients induced by inductive load switching and lighting on ICs, MOSFET, signal lines of sensor units for consumer, automotive, and telecommunication.

Mechanical Data

- **Package:** DO-214AA (SMB)
Molding compound meets UL 94 V-0 flammability rating, RoHS-compliant, halogen-free
- **Terminals:** Matte tin plated leads, solderable per J-STD-002B and JESD22-B102D
- **Polarity:** For uni-directional types the band denotes cathode end, no marking on bi-directional types

■Maximum Ratings ($T_a=25^\circ\text{C}$ Unless otherwise specified)

PARAMETER	SYMBOL	UNIT	Max
Peak power dissipation, with a 10/1000us waveform ⁽¹⁾ ⁽²⁾ (Fig.1)	P_{PPM}	W	1000
Peak pulse current, with a 10/1000us waveform ⁽¹⁾	I_{PPM}	A	See Next Table
Power dissipation, on infinite heat sink at $T_L=75^\circ\text{C}$	P_D	W	5.0
Peak forward surge current, 8.3 ms single half sine-wave unidirectional only ⁽²⁾	I_{FSM}	A	100
Operating junction	T_J	$^\circ\text{C}$	-55 to +175
Storage temperature range	T_{STG}	$^\circ\text{C}$	-55 to +175

■Electrical Characteristics ($T_a=25^\circ\text{C}$ Unless otherwise specified)

PARAMETER	SYMBOL	UNIT	VALUE
Maximum instantaneous forward voltage @ at 50A for unidirectional only	V_F	V	3.5



1.0SMB SERIES

■ Thermal Characteristics (T_a=25°C Unless otherwise specified)

PARAMETER	SYMBOL	UNIT	Conditions	VALUE
Thermal resistance(Typical)	R _{θJL}	°C/W	junction to lead	20
	R _{θJA}	°C/W	junction to ambient	100

Notes:

- (1) Non-repetitive current pulse, per Fig. 3 and derated above T_A= 25°C per Fig.2.
- (2) Thermal resistance from junction to ambient and from junction to lead mounted on P.C.B. with 0.3" x 0.3" (5.0 mm x 5.0 mm) copper pad areas

■ Electrical Characteristics (T_a=25°C Unless otherwise specified)

Part Number (Uni)	Part Number (Bi)	Breakdown Voltage V _{BR} @I _T			Maximum Reverse Leakage I _R ⁽⁵⁾ @ V _{RWM} (μA)	Working Peak Reverse Voltage V _{RWM} (V)	Maximum Reverse Surge Current I _{PP} ⁽⁴⁾ (A)	Maximum Clamping Voltage V _c @ I _{PP} (V)
		Min(V)	Max (V)	I _T ⁽³⁾ (mA)				
1.0SMB6.8AQ	1.0SMB6.8CAQ	6.46	7.14	10	1000	5.8	95.2	10.5
1.0SMB7.5AQ	1.0SMB7.5CAQ	7.13	7.88	10	500	6.4	88.5	11.3
1.0SMB8.2AQ	1.0SMB8.2CAQ	7.79	8.61	10	200	7.0	82.6	12.1
1.0SMB9.1AQ	1.0SMB9.1CAQ	8.65	9.56	1	50	7.8	74.6	13.4
1.0SMB10AQ	1.0SMB10CAQ	9.50	10.50	1	10	8.6	69.0	14.5
1.0SMB11AQ	1.0SMB11CAQ	10.45	11.55	1	5	9.4	64.1	15.6
1.0SMB12AQ	1.0SMB12CAQ	11.40	12.60	1	5	10.2	59.9	16.7
1.0SMB13AQ	1.0SMB13CAQ	12.35	13.65	1	5	11.1	54.9	18.2
1.0SMB15AQ	1.0SMB15CAQ	14.25	15.75	1	5	12.8	47.2	21.2
1.0SMB16AQ	1.0SMB16CAQ	15.20	16.80	1	5	13.6	44.4	22.5
1.0SMB18AQ	1.0SMB18CAQ	17.10	18.90	1	5	15.3	39.7	25.2
1.0SMB20AQ	1.0SMB20CAQ	19.00	21.00	1	5	17.1	36.1	27.7
1.0SMB22AQ	1.0SMB22CAQ	20.90	23.10	1	5	18.8	32.7	30.6
1.0SMB24AQ	1.0SMB24CAQ	22.80	25.20	1	5	20.5	30.1	33.2
1.0SMB27AQ	1.0SMB27CAQ	25.65	28.35	1	5	23.1	26.7	37.5
1.0SMB30AQ	1.0SMB30CAQ	28.50	31.50	1	5	25.6	24.2	41.4
1.0SMB33AQ	1.0SMB33CAQ	31.35	34.65	1	5	28.2	21.9	45.7
1.0SMB36AQ	1.0SMB36CAQ	34.20	37.80	1	5	30.8	20.0	49.9
1.0SMB39AQ	1.0SMB39CAQ	37.05	40.95	1	5	33.3	18.6	53.9
1.0SMB43AQ	1.0SMB43CAQ	40.85	45.15	1	5	36.8	16.9	59.3
1.0SMB47AQ	1.0SMB47CAQ	44.65	49.35	1	5	40.2	15.4	64.8
1.0SMB51AQ	1.0SMB51CAQ	48.45	53.55	1	5	43.6	14.3	70.1
1.0SMB56AQ	1.0SMB56CAQ	53.20	58.80	1	5	47.8	13.0	77.0
1.0SMB62AQ	1.0SMB62CAQ	58.90	65.10	1	5	53.0	11.8	85.0
1.0SMB68AQ	1.0SMB68CAQ	64.60	71.40	1	5	58.1	10.9	92.0

Notes:

- (3) Pulse test: t_p≤50ms.
- (4) Surge current waveform per Fig. 3 and derated per Fig.2.
- (5) For bi-directional types having VRWM of 10 V and less, the I_R limit is doubled.



1.0SMB SERIES

■ Characteristics (Typical)

Fig.1 Peak Pulse Power Rating Curve

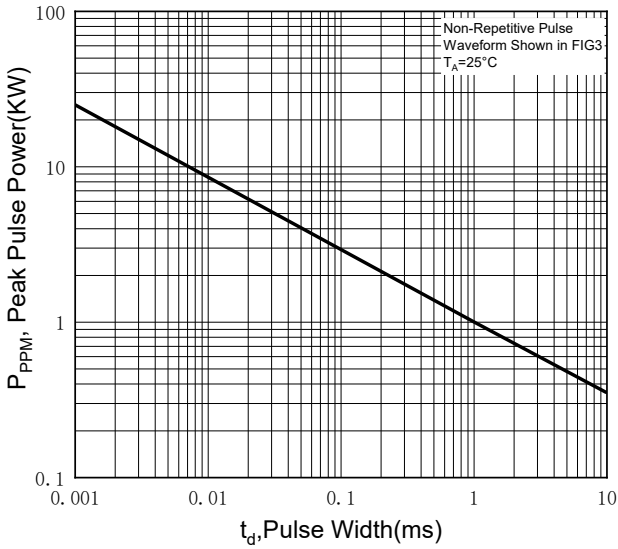

Fig.2 Pulse Power or Current vs. Initial Junction Temperature

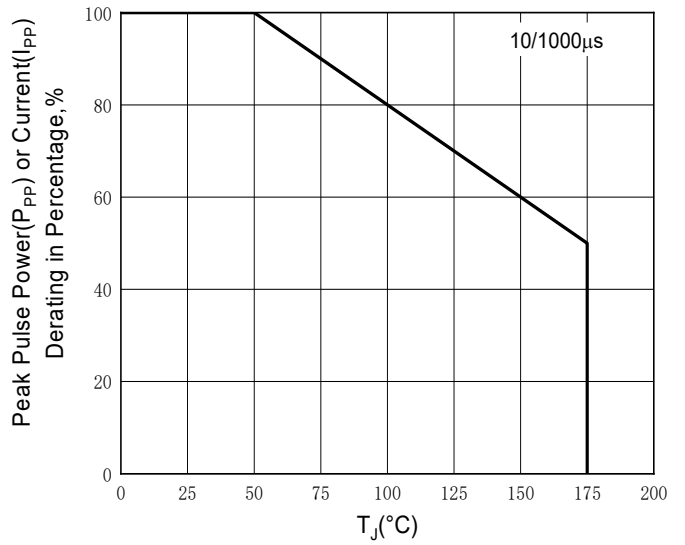

Fig.3 Pulse Waveform

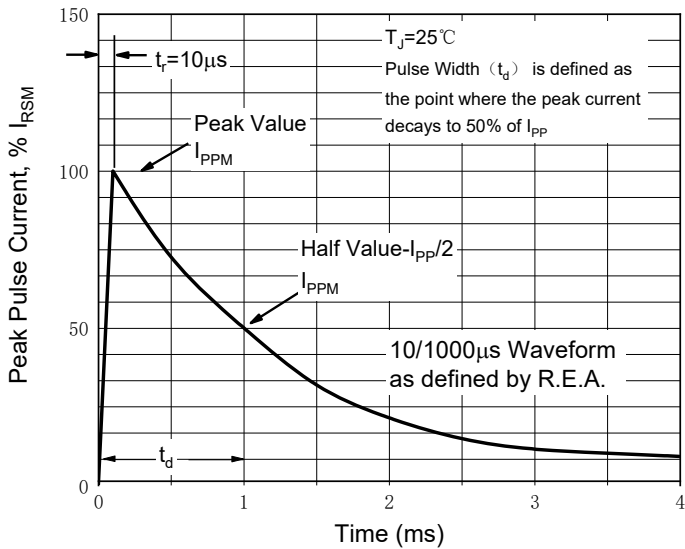

Fig.4 Typical Transient Thermal Impedance

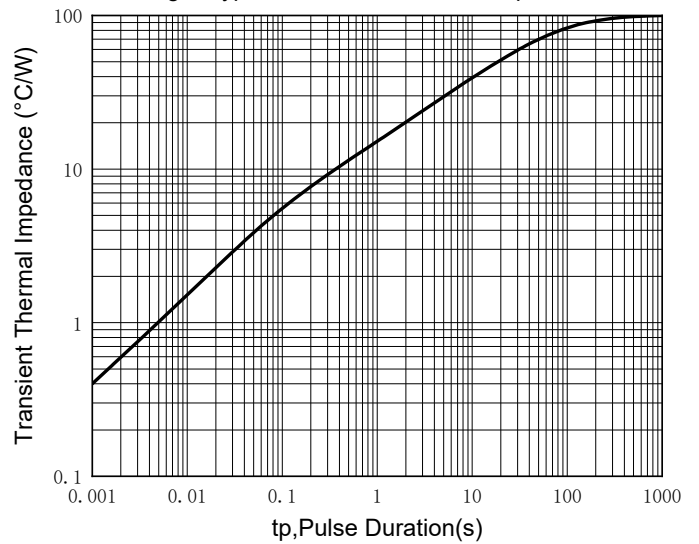

Fig.5 Maximum Non-Repetitive Forward Surge Current

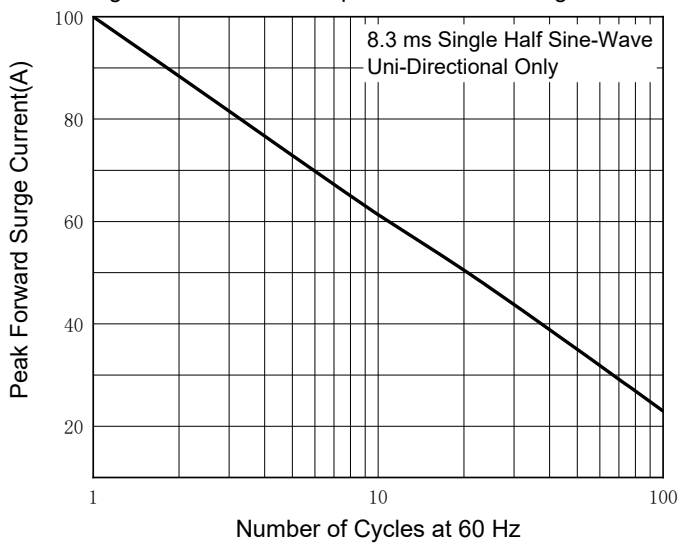
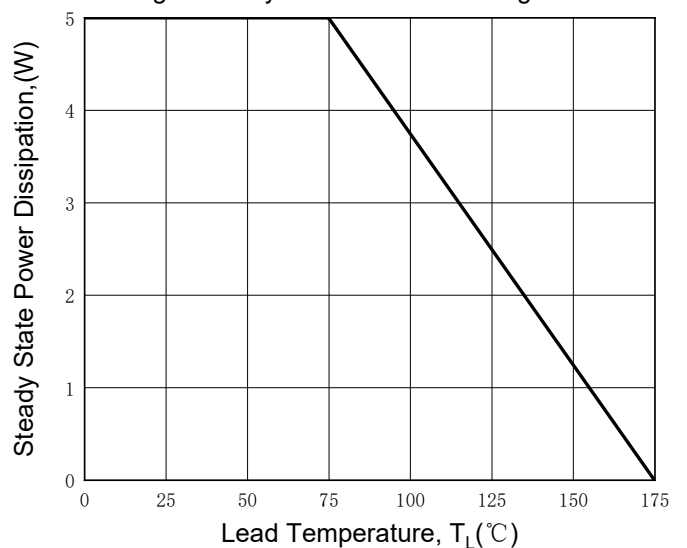

Fig.6 Steady State Power Derating Curve





1.0SMB SERIES

Ordering Information (Example)

REFERED P/N	PACKING CODE	UNIT WEIGHT(g)	MINIMUM PACKAGE(pcs)	OUTER CARTON QUANTITY(pcs)	DELIVERY MODE
1.0SMB SERIES	F1	0.0975	3000	48000	13" reel

Outline Dimensions

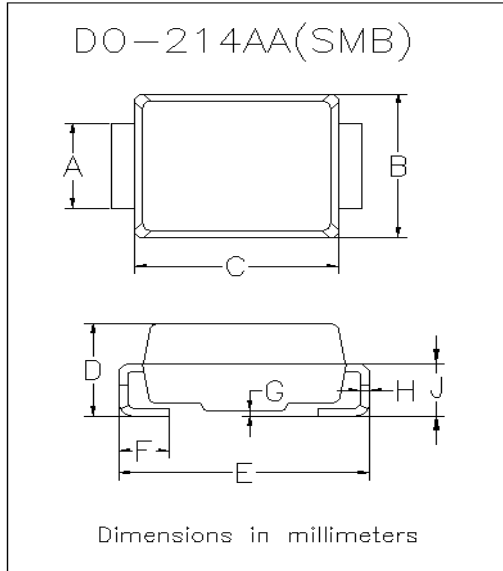

DO-214AA(SMB)		
Dim	Min	Max
A	1.85	2.15
B	3.30	3.94
C	4.05	4.75
D	1.99	2.61
E	5.21	5.59
F	0.90	1.41
G	0.05	0.20
H	0.15	0.31
J	1.05	1.55

Suggested pad layout

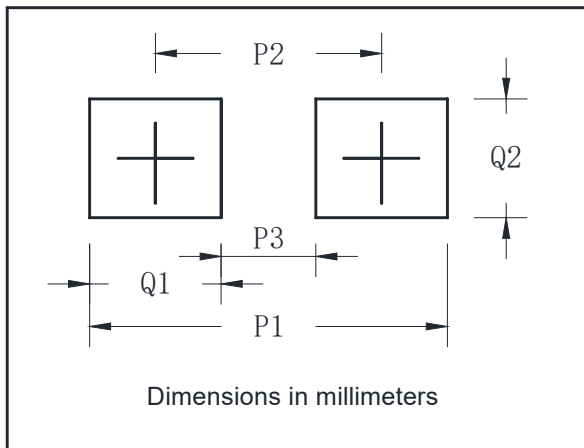

DO-214AA(SMB)	
Dim	Millimeters
P1	6.8
P2	4.3
P3	1.8
Q1	2.5
Q2	2.3



1.0SMB SERIES

Disclaimer

The information presented in this document is for reference only. Yangzhou Yangjie Electronic Technology Co., Ltd. reserves the right to make changes without notice for the specification of the products displayed herein to improve reliability, function or design or otherwise.

The product listed herein is designed to be used with automotive electronics, are not designed for use in medical, lifesaving, lifesustaining, or military, Yangjie or anyone on its behalf, assumes no responsibility or liability for any damages resulting from such improper use of sale.

This publication supersedes & replaces all information previously supplied. For additional information, please visit our website [http:// www.21yangjie.com](http://www.21yangjie.com) , or consult your nearest Yangjie's sales office for further assistance.